

Data Sheet



Article number: 2310421548

Description: E+G Latch w/recessed key
CQT/T-FM-35-25-CR

Measures

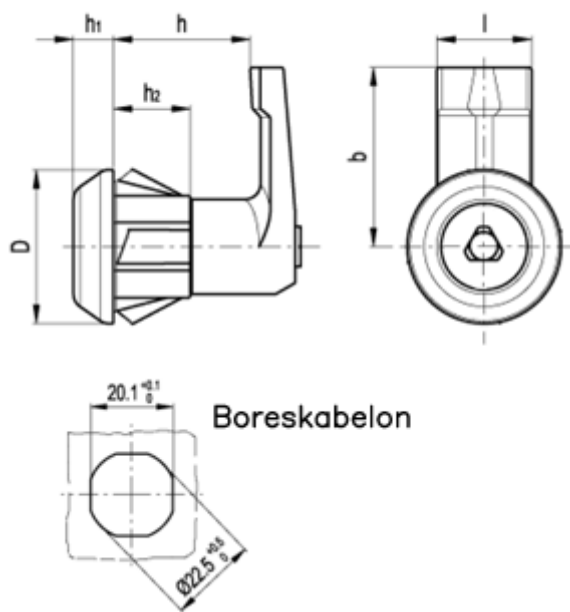

b	= 35
D	= 30
h	= 25
h1	= 8
h2	= 15
l	= 18.5
Weight	= 22